

Instructions for Models:

S-1564

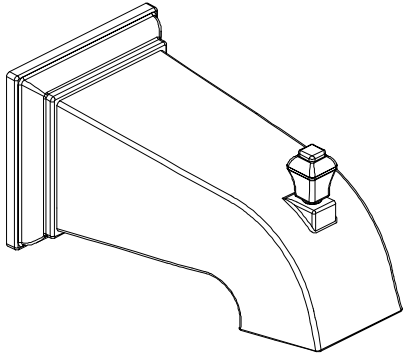

Need Help?

For additional assistance or service call:

SPEAKMAN Company
400 Anchor Mill Road
New Castle, DE 19720

PHONE: 800-537-2107
EMAIL: customerservice@speakmancompany.com
WEB: www.speakmancompany.com

92-3322-R1

What You Need To Know:

Tools:

Required:

*Allen Wrench (Included)



Helpful:

* Tubing Cutter

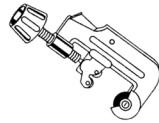

*Hacksaw

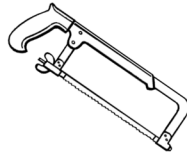

*Protective Eye Wear



Important Notes:

Be sure to read instructions thoroughly before beginning installation. Do not overtighten any connections or damage may occur.

Safety Tips:

Cover your drain to prevent loss of parts.
Be sure to wear eye protection while cutting pipe.

Maintenance:

Your new Tub Spout is designed for years of trouble-free performance. Keep it looking new by cleaning it periodically with a soft cloth. Avoid abrasive cleaners, steel wool, and harsh chemicals as these will dull the finish and void your warranty.

① The minimum distance between the center off the tub spout and the rim of the tub should be no less than 4".

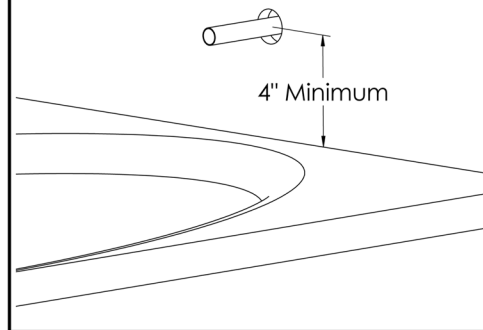

② The stub out for the 1/2" pipe should extend a minimum of 1.75" from the wall, but not to exceed 3" from wall. Remove all burrs and sharp edges from the stub out 1/2" pipe.

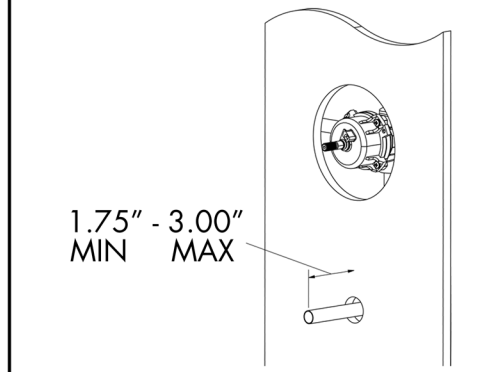

③ Slide spout (1) over exposed stub out pipe until flush to wall. Center the spout (1) on the wall and tighten set screw (2) from underneath with Allen wrench

